

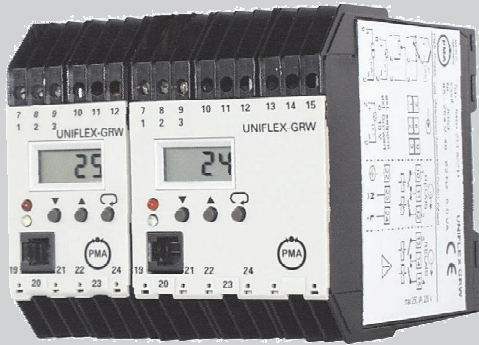

UNIFLEX GRW

Tripalarm with Universal Input



Pt100, Thermocouple, Resistance transducer, Potentiometer, Voltage, Current

Output with 2 or with 4 contacts

Hold function for alarms

External setpoint

Adjustment via front key or PC

CE tested

PROFILE

The UNIFLEX GRW tripalarm provides solutions for measurement and monitoring in process control and other industrial applications. Temperature, voltage, current, and resistive signals can be connected without the need for any hardware changes. The built-in display allows configuration and parameter setting via the front panel keys. Via a PC and connecting adapter, the tripalarm also can be configured and adjusted remotely. This also allows documentation of the adjusted parameters, as also reading of the input signal and parameters during operation.

DESCRIPTION

The tripalarm has independent signal inputs for thermocouples, resistance thermometers, resistance transducers, DC-voltage and DC-current. For thermocouple measurement, the cold-junction compensation is provided by a built-in sensor. Resistance thermometers are to be connected in 3-wire connection. Signals (temperature sensors included) can be linearized with up to 8 segments.

Password

A password freely selectable prevents unauthorized access to configuration and parameter setting.

Input circuit monitor

Resistance thermometer, thermocouples, resistance transducers are always monitored for break.

Sensor signal correction

Sensor signal correction is used to match sensor and tripalarm for tolerance-compensated readings. Two different corrective methods are available:

- Correction with lower and upper input signal within the selected span or
- Setting of values from the calibration

Fig. 1 sensor signal correction

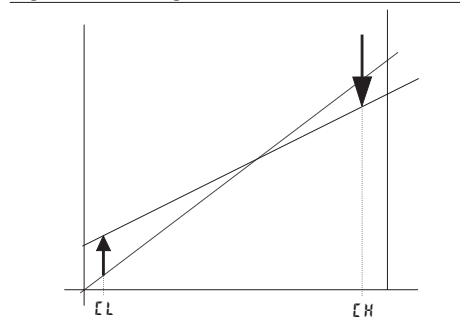

table (scaling).

Subsequent corrections during operation are possible with both versions, by means of the front panel key(s). The curve can be adjusted for offset and for gain.

Limit signalling

- Min. and max. alarm (adjusted in engineering units)
- Adjustable between -10 and 110 % referred to the output signal span.

Alarm-hold function

Via SW the hold of an alarm can be selected. Reset is by means of the combination of two front keys.

Hysteresis

- programmable in engineering units or in % in the range from 0,0... 99,9 % referred to the output signal span.

Signal suppression (response delay)

- programmable from 0... 9999 s. All alarms shorter as the selected time gap are ignored.

Signalling

- red LED in front panel (lights up on alarm)
- with switching output (selection of energized or de-energized or no operation)

Filter

Built-in is a 1st-order mathematical filter. It is adjustable for time constant and bandwidth.

Fig.2 Filter function

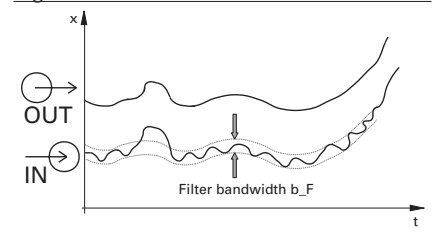

The bandwidth is the tolerance above and below the process value, in which the filter is active. Changes of the process value larger than the adjusted bandwidth are not filtered and will be transferred directly to the output.

Fig. 3 Dimensions (in mm)

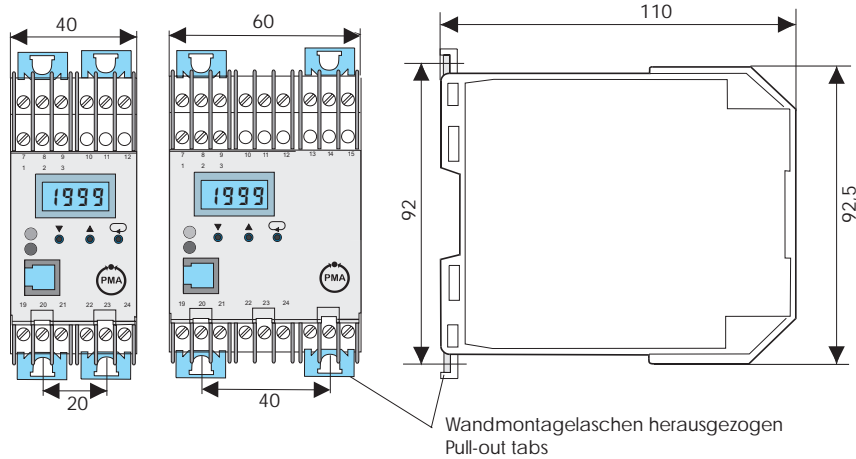

TECHNICAL DATA

INPUT (CONFIGURABLE)

Resolution: approx. 20 000 steps referred to full span.

Measuring cycle: 100 ms

THERMOCOUPLE

Measurement limits (TC group 1)
smallest span 4 (2) mV¹⁾

Type	Span start [°C]	Span end [°C]
E	-100	1000
J	-100	1200
L	-100	900
K	-100	1370
N	-100	1300
T	-100	400
W(C)	0	2315

Measurement limits (TC group 2)
smallest span 2 mV

Type	Span start [°C]	Span end [°C]
R	0	1760
S	0	1760
B	0	1760

Input resistance: 1MΩ

Linearization

built-in (temperature linear)

Conformity error

for TC-group 1: ≤ 0,2 K
for TC-Group 2: ≤ 0,5 K

Input circuit monitor

for break and reversed polarity

Cold-junction-compensation

internal or external (0...60 °C)
Selectable

Display error: ≤ 3 K ± 1 digit

RESISTANCE THERMOMETER PT100 DIN IEC

Measurement limits: -200...+850 °C
Smallest span: 50 (25) K
Sensor current: 0,4 mA

Connection technology

Three-wire
Lead resistance: ≤ 30 Ω per wire
Input resistance: 1 MΩ

Linearization

built-in

Conformity error: ≤ 0,1 K

Input circuit monitor: for break

Display error: ≤ 1 K ± 1 digit

RESISTANCE & POTENTIOMETRIC TRANSDUCER

Range	Smallest span	Current
0...400 Ω	20 Ω (10) ¹⁾	0,4 mA
0...1500 Ω	50 Ω	0,1 mA

(Including lead resistance)

Input resistance: 1MΩ

Connection

Transducer: 3-wire connection, current through resistor

Resistance: 3-wire connection

Input circuit monitor: for break

DIRECT VOLTAGE

mV signals, direct

Range 1: - 3...23 mV, min. 2,5 mV
Range 2: -11...69 mV, min. 9 mV
Range 3: 0...160 mV, min. 15 mV
Input resistance: 1 MΩ

V signals via internal voltage divider

Range 1: - 0,6...4,4 V, min. 400 mV
Range 2: - 2...13 V, min. 1000 mV
Range 3: 0...30 V, min. 2000 mV
Input resistance : approx. 100 kΩ

DIRECT CURRENT

Range 1: -1...7,3 mA, min. 1 mA
Range 2: - 3...22 mA, min. 2 mA
Range 3: 0...50 mA, min. 4 mA
Input resistance: approx. 18 Ω

Additional linearization

for all input signals possible with 8 segments and 9 supporting points, permits even correction of standard linearisation curves.
(Potentiometric transducers excluded).

External setvalue

0...10 V from PLC or similar. Not galvanical from input circuitry isolated. Activated on contact 1 via SW

Permissible interference at input

to DIN IEC 770 6.2.4

Common mode suppression: negligible
Series mode: no effect up to 450 mV_{rms} for TC (type S)
1 V_{rms} for mV (0...50 mV)
750 mV_{rms} for Pt100 (0...100 °C)
10 V_{rms} for DC 0...4 V / 0...5 mA

OUTPUT

CONTACT OUTPUT

Relay with potential-free normally open contact. Contact rating: max. 250 VAC, 1A min. 5 V, 0,1 A. Energized or de-energized operation configurable.

Hysteresis

programmable in engineering units or in % in the range from 0,0... 99,9 % referred to the output signal span.

Signal suppression (response delay)

programmable from 0... 9999 s. All alarms shorter than the selected time gap are ignored.

Operating mode

selectable for input circuit monitoring and/or limit signalling.

Alarm-hold function

Via SW the hold of an alarm can be selected. Reset is by means of the combination of two front keys.

Input circuit monitor

Output action selectable upscale or downscale.

Dynamic response

For a step change from 10 to 90 % of input signal
Output follows input: approx. 250 ms

¹⁾ Figure in brackets, twice the effect

Fig. 4 Configuration word 1

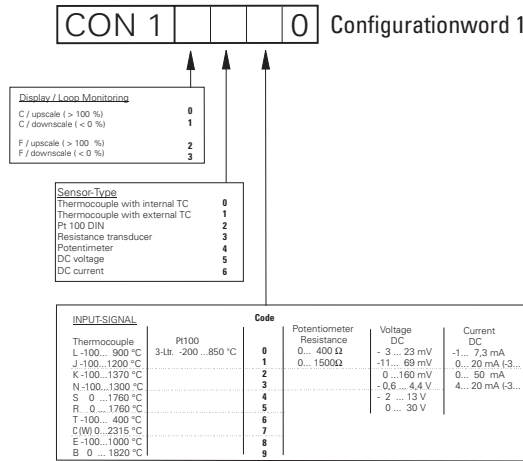

Fig. 5 Configuration word 2

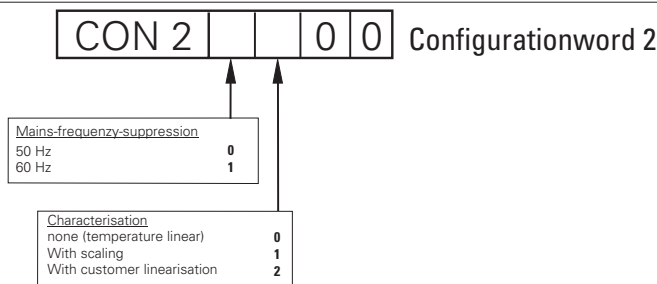

Fig. 6 Configuration word 3

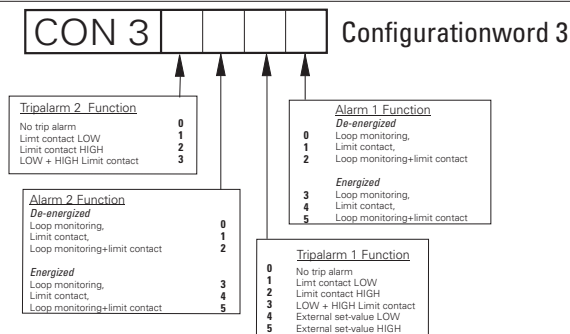
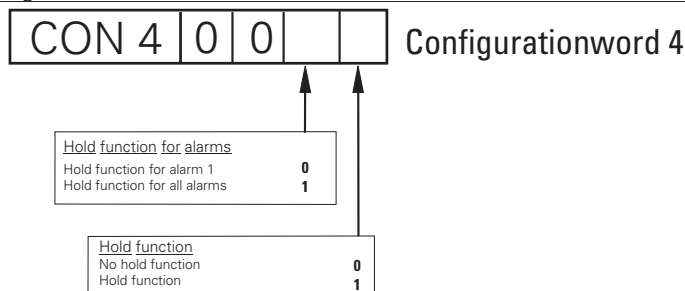

Fig. 7 Configuration word 4



DISPLAY

4-digit LCD, 7 mm high, with front panel keys for configuration and parameter setting

Characteristic: linear

Conformity error: including factory calibration error $\leq 0,06\%$ of fsd

Reproducibility: $\leq 0,01\%$

Factory calibration: at 23 °C
RT ± 1 K, TC ± 2 K

Green LED: ready for operation

Red LED: input circuit monitor or limit signaller activated. Blinking mode during operation with sensor signal correction.

OPERATION

Configuration, Parameter setting and input signal correction are menu-guided via three front-panel keys. A password freely selectable avoids unauthorized access to configuration and parameter setting. Release of alarm by pushing two front keys in parallel.

PC-based operation

Additional software is available (Engineering tool based on Windows) for configuration, parameter setting, and input signal correction.

SERIAL INTERFACE

RS 232C with active adapter for PC based operation with engineering tool

POWER SUPPLY

AC(DC) SUPPLY

85...264 VAC⁴⁾, 50 or 60 Hz

Consumption

2 relays approx. 4,8 VA
4 relays approx. 7,2 VA

UNIVERSAL SUPPLY

18...32 VDC / 24 VAC +10-15 %

Consumption

2 relays approx. 1,1 W / 1,8 VA
4 relays approx. 1,5 W / 2,4 VA

Power supply effect

negligible within specified limits.

Behavior with mains failure

no loss of configuration data.

GALVANICAL ISOLATION

Between input and output and power supply.

Test voltages

Between input and output: 500 VAC
Between mains and in-/output: 2,3 kVAC

ENVIRONMENTAL CONDITIONS

Temperature limits

For specified accuracy: 0...55 °C
For operation: -10 ... + 60 °C
Storage: -20 ... + 70 °C

Temperature effect

(within -10...+ 60 °C)

On span start

R - input: $\leq 0,03\%$ / 10K
TC/U/I - input: $\leq 0,04\%$ / 10K

On span

R - input: $\leq 0,05\%$ / 10K
TC/U/I - input: $\leq 0,075\%$ / 10K

Effect of internal cold junction compensation

$\leq 0,13$ K / 10 K (after warming up)

Relative humidity

90 % rH, no condensation

Shock and vibrations

DIN IEC 68-2-6/Fc and DIN 68.2.29/Eb

¹⁾ With DC voltage limited use possible

ELECTROMAGNETIC COMPATIBILITY

Complies with EN 50081-1 / EN 50082-2 for unlimited use within rural and industrial areas.

EXPLOSION PROTECTION

No explosion protection

SAFETY CHARACTERISTICS

According to EN 61010-1
Excess-voltage category II
Pollution degree 2
Operating voltage range 300 V
Protective class I

CE-marking

According to European directives for "Electromagnetic compatibility" and "Electrical equipment use within specified voltage limits (safety characteristics).

ORDERING INFORMATION

If not specified otherwise, the tripalarm will be delivered with the following standard settings:

Standard version CON1 0200, CON2 0001
Range 0...150 °C. Pt100, 3-wire Input circuit monitoring upscale action. Switching output de-energized, set to span start and end. Hysteresis 5 K, suppression 2s, filter time 0,1 s, bandwidth 5 K. Password mode activated, password 0

GENERAL

Dimensions

2 Contacts: 93 x 111 x 40 mm
4 Contacts: 93 x 111 x 60 mm

Mode of Protection

Housing and terminals IP30

Electrical connection

screw terminals for max. 2,5 mm²

Weight

2 contacts: 0,23 kg net
4 contacts: 0,3 kg net

Mounting: 35 mm rail to DIN 46277 or wall

Mounting position

Vertical. Dense mounting and temperatures ≥ 50 °C forced ventilation recommended.

ACCESSORIES

Operating notes: D / E / F
9499-040-57601

OPTIONAL ACCESSORIES

Description	Order-no
Adapter for connection of UNIFLEX DMS to a RS232 interface of a laptop or PC	9407-998-00001
Engineering tool for setting of configuration and parameters, read-out and documentation, base Windows from 3.11 onwards On CD-ROM Licence (1x)	9407-999-00801

Fig. 8 Configuration word 5

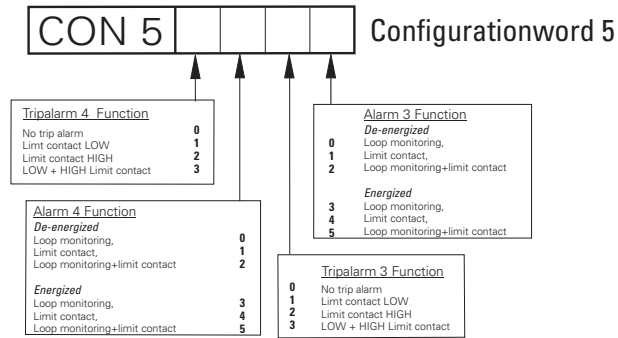
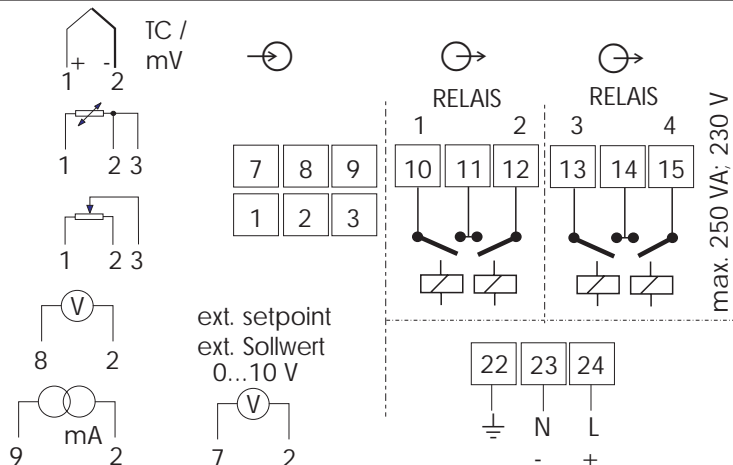
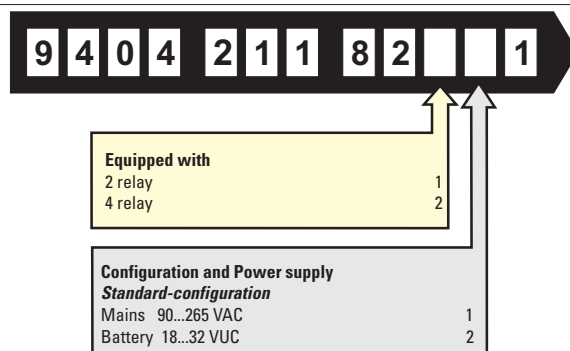

Fig. 9 Electrical connections



ORDERING STRUCTURE



Deutschland
PMA Prozeß- und Maschinen- Automation GmbH
Miramstrasse 87, D-34123 Kassel

Your local distributor

Tel./Fax: (0561) 505 - 1307/-1710
E-mail: mailbox@pma-online.de
Internet: http://www.pma-online.de