



Data monitor KS 3010



Acquisition of measurement data with a sampling rate of 125 ms

Colour display, no paper charts, no printing system

Optional functions as point or line recorder

6 or 12 freely programmable universal inputs with galvanic isolation

Up to 6 display groups with max. 6 analog and 3 digital input signals per group

Choice of display formats per group: vertical/horizontal diagram, numeric and bargraph display

PROFIBUS-DP and/or RS 232/RS 422/RS 485 interfaces

Programmable storage cycle and value for normal, event, or timed operating mode

Data analysis in the monitor or with evaluation software in a PC

PROFILE

The data monitor KS 3010 is a freely programmable, microprocessor-controlled device for measuring, storing, visualizing, and analysing process data. Fitted with 6 or 12 universal inputs (or PROFIBUS-DP), the KS 3010 accepts signals from direct current and voltage sources, thermocouples, resistance thermometers, and potentiometric transducers.

The measured data are stored in a RAM, where they are available for display on the colour screen, and for evaluation. For long-term storage, the data are written onto a diskette that can also be used for subsequent evaluation and analysis on a PC by means of suitable software.

The data monitor KS 3010 is intended for use in industrial applications and is designed for panel mounting in a cut-out of 138 x 138 mm. The front panel has protection class IP 54 and measures 200 x 144 mm.

DESCRIPTION

Measurement and inputs

The KS 3010 has 6 or 12 universal analog inputs (or a PROFIBUS-DP port) for direct current and voltage signals, thermocouples, resistance thermometers, and potentiometric transducers. Sensor type and measurement range are freely configurable per input. Internal linearization is provided for thermocouple and resistance thermometer signals. The inputs are galvanically

isolated by means of opto-couplers.

The sampling rate is fixed at 125 ms (regardless of the number of inputs), enabling the unit to be used as a point or line recorder.

When fitted with a PROFIBUS-DP interface, up to 32 input signals can be connected to the KS 3010.

As an option, 7 digital (binary) inputs can be fitted in addition to the analog inputs. Furthermore, every KS 3010 has 2 counters for max. 10.000 steps, which can be configured for up/down counting, starting value, and trigger signal.

Operation and configuration

Operation and configuration of the data monitor is menu-guided by means of 8 keys in the front panel. Five of the keys are „softkeys“ whose functions are context-dependent according to the selected display. This ensures confident operation, because the permitted functions are always displayed at the bottom of the screen in plain text or as symbols.

Unauthorized access to the configuration can be password-protected. Configuration data can be uploaded onto a diskette from the KS 3010, or downloaded from a diskette into the KS 3010. By means of an Engineering Tool (ET, see Accessories), the unit can be configured via a PC. The ET offers the advantage of faster text entries and convenient computation of the data storage capacity (duration) for the ring buffer

and the diskette. Configuration data can be stored in an archive and/or routed to a printer. Alternatively, the ET can be used to generate a diskette with configuration data that can be uploaded into a KS 3010. Similarly, the data can be uploaded via the front-panel socket and a PC interface cable with adapter (see Accessories).

The operating and configuration language is selectable on-screen for English, German, French, Dutch, Spanish, Italian, Czech, Hungarian, Polish, Danish or Swedish. The Engineering Tool provides a choice of English, German, French, Dutch, Spanish, and Italian.

PC-based evaluation software

This software package (see Accessories) runs under Windows 95/98 or NT and is used for visualization, evaluation, administration and archiving of measurement data stored by the KS 3010. Data can be read from the diskette or via the RS 232/422/485 interface with the communication Server (Accessories). The communication server allows a timed read-out of data stored in the RAM via the serial interface. The available functions are as follows:

- The data from differently-configured monitors is recognized and stored in a data base. The entire data administration is executed automatically. The user only has to enter an identifier.
- The user has direct access to data which has been specified by means of the identifier.
- Furthermore, the periods to be evaluated can be limited.

- New display groups can be configured at any time by assigning the required analog and digital inputs.
- Because each group is displayed in its own window, two or more groups can be displayed simultaneously, e.g. for comparison.
- As far as possible, the PC display is the same as the KS 3010 display.
- An export filter enables the data to be transferred to other programs, e.g. Excel, for further calculations.

Visualization

For visualization, the KS 3010 is fitted with a 5,7-inch (145 mm) STN colour graphics display with a resolution of 320 x 240 pixels. A 16-value grey scale and 27 colours ensure brilliant displays. The KS 3010 has an internal Group Manager with which the available input signals can be freely assigned to one or more display groups. Display groups provide improved transparency and allow individual parameters (e.g. storage cycle or stored data) to be configured individually for the group. The Group Manager handles up to 6 display groups, whereby each group can contain 6 analog and 3 digital channels. Within each group, different display formats are possible: vertical/horizontal diagram, individual and group data in numeric form, and bargraph displays (see examples at right). The vertical and horizontal diagram can be switched over to show a historic display of the stored data in the RAM, e.g. for analysis.

Various reports can be generated for every analog channel, e.g. periodic or external, as well as daily, monthly, or annual reports.

Min, max, mean, or integral value plus the time period can be displayed per channel. The integrator enables flow rates or filling levels to be computed and displayed.

Similarly, event lists are possible for recording exceeded limits, external control signals, counter values, system messages, and user-defined texts.

In connection with an external report, it is possible to generate batch protocols. Start, end, and duration of a batch are recorded. Together with a batch counter and freely definable texts, the times can be displayed by the KS 3010 or the PC-based evaluation software. Individual batch records can be started e.g. via:

- digital inputs 1...7 (optional)
- Modbus flag (serial interface).

Vertical diagram

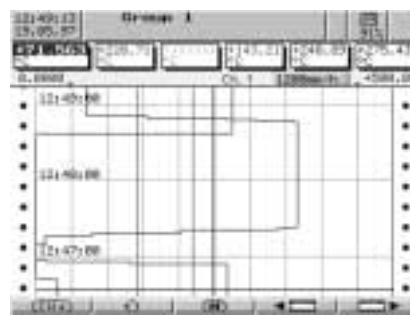

- Recorder chart presentation of analog channels
- Scaling and limit markers for the selected channel
- Numeric display of all analog channels

Horizontal diagram

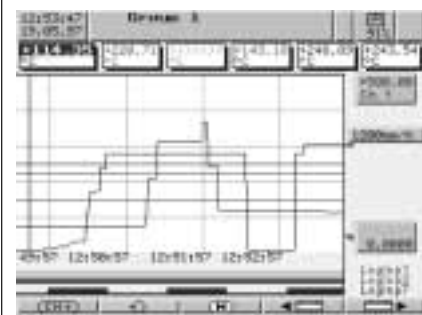

- Trend display of analog and digital channels
- Scaling and limit markers for the selected channel
- Numeric display of all analog channels

Numeric group display



- Large, numeric display of the analog channels plus 2 lines of supplementary text
- Selected channel are brought to the foreground
- On/off status display of the digital channels

Individual numeric display

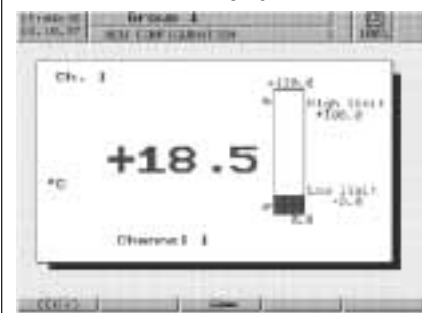

- All relevant data of the selected channel is shown in a large, clear presentation
- Simultaneous display as a bargraph and numeric value
- Display of the 2-line supplementary text
- indication of scaling and limit markers

Bargraph display

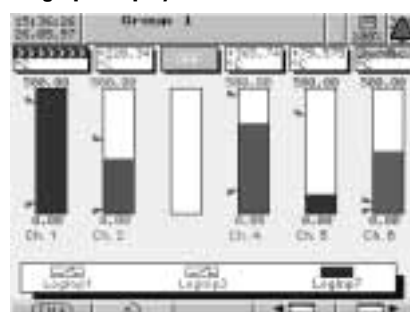

- Bargraph presentation of the analog channels
- On/off status display of the digital channels
- Scaling and limit markers for each channel
- Bargraph colour changes to red with an exceeded limit

Report

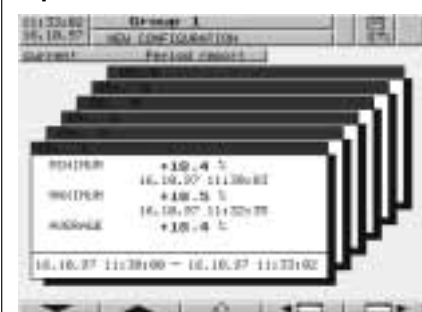

- Report of a selected channel in its own window
- Display of minimum, maximum, mean/integral values, and time period
- Display of the previous report

Data processing

The input values are sampled cyclically at fixed intervals of 125 ms, and are stored in a buffer memory. The stored data is checked for exceeded limits and is also used for reports. Reports can be generated for each channel (minimum, maximum, mean, and integral values) and for a defined period.

Depending on the configured storage cycle, storage mode, and storage data (min, max, mean or current value), the measurement results are then passed to a ring buffer (RAM) which has a capacity of 896 kbytes.

If a limit value is exceeded, an alarm is triggered. This alarm signal can be used e.g. to switch to a different storage mode.

There are three storage modes, each of which can be configured for storage cycle and storage data:

- Normal mode is the default setting.
- Event mode is triggered by an external signal (digital input, group or common alarm, etc.) and remains active as long as the trigger signal is present.
- Timed mode is executed once a day during a pre-defined time.

The operating modes have the following priorities:

Event mode prior to timed mode, timed mode prior to normal mode.

Data stored in the RAM are copied onto a diskette in 8 kbyte blocks at regular intervals. The RAM is operated as a ring buffer, i.e. when it is full, the oldest data are overwritten by the newest data.

The diskette used for permanent storage is a conventional 3½-inch floppy (DOS) with a capacity of 1,44 Mbyte. Because the internal disk manager verifies every write process, disk faults are recognized immediately, and an error message is generated. The disk manager also monitors the remaining disk capacity and generated an alarm as soon as a pre-defined „disk reserve“ capacity is reached. The alarm signal can be used to trigger a relay (e.g. „change diskette“).

With the „disk update“ function, the disk manager copies any data from the RAM which has not yet been stored, before a diskette is removed.

Measurement data are stored on the diskette in a special encryption code. If the diskette is removed from the unit, there is no immediate loss of data, because operation of the RAM is not affected. Only when the RAM is full, and there is no diskette in the drive, data will be overwritten. The disk manager remembers which data have been saved to diskette.

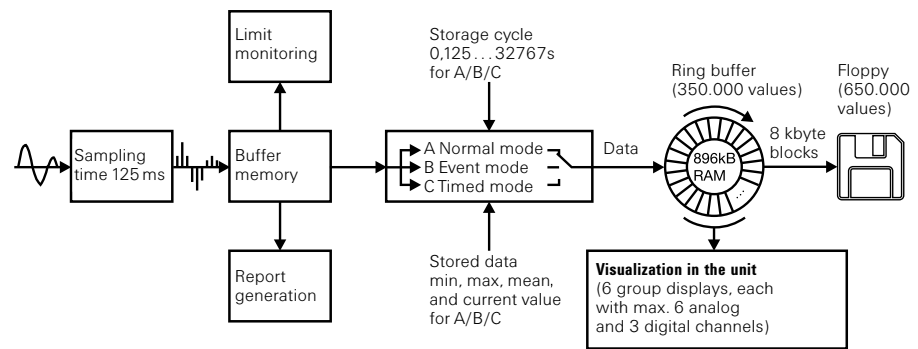

As soon as a new disk is inserted, any data not yet saved will be written to the disk immediately. If data has already been overwritten, the entire RAM contents are written to the disk.

The memory requirement (storage duration) depends on the configuration of the KS 3010, and can vary between a few minutes up to several months. Calculation of the storage duration for the RAM ring buffer and the diskette can be carried out with the Engineering Tool.

Example:

- 1 group with 6 analog and 3 digital inputs (storage cycle of 30 s)
- 1 periodic report every 2 hours (without integrator)

This results in a recording capacity of approx. 28 days for the diskette, and approx. 17 days for the RAM. If a longer storage cycle is used, e.g. every 2 minutes, the recording capacities are increased to approx. 106 days for the diskette, and approx. 64 days for the RAM.

With longer storage cycles, the event recording mode can also be used to switch over to a shorter cycle time in case of an alarm. This means that a „generous“ cycle time can be configured for normal, trouble-free operation to provide sufficient data e.g. for a daily trend record. As soon as a special condition (event) occurs, which requires a more detailed record, the KS 3010 is switched into the event recording mode (short cycle time).

Interfaces

The current process data (analog signals and digital events) and special monitor data can be output via the RS 232 or RS 422/RS 485 interface. As standard, the KS 3010 is fitted with the RS 232 interface which allows up to 15 m of cable. With RS 422/RS 485 the cable can be up to 500 m long.

All interface ports are connected via a 9-pin D-type female connector at the rear of the unit. Transmission protocols for Modbus and J-bus are available. The transmission mode is RTU (Remote Terminal Unit).

By means of the PMA communication server (see Accessories), it is possible to read the data stored in the RAM ring buffer of the KS 3010 via the RS 232/422/485 interface at timed intervals.

Furthermore, the interface allows up to 24 external analog inputs and 6 digital inputs to be connected to the KS 3010.

In the version with a PROFIBUS-DP interface, the KS 3010 can be operated as a slave in a field bus system in accordance with the PROFIBUS standard. Via this interface, up to 36 external analog inputs and 6 external digital inputs can be handled by the KS 3010 for visualization and recording purposes. Alternatively, the data of the internal 6/12 analog inputs and max. 6 internal digital inputs can be read out of the KS 3010 via the PROFIBUS-DP interface.

Data is transmitted serially at max. 12 Mbit/s according to the RS 485 standard. With the help of the projecting tool „GSD generator“ (supplied), an application-specific GSD file is produced, with which the KS 3010 is linked into the field bus system.

An Ethernet link can be provided for the KS 3010 via an external COM server module.

TECHNICAL DATA

INPUT

Analog inputs

Configurable for sensor type and measuring range.

Galvanic isolation between inputs: up to 30 VAC or 50 VDC by means of opto-couplers.

Sampling rate

125 ms for 1, 6 or 12 inputs.
Resolution: > 14 bits

Thermocouples

Type	Max. meas. range
Fe-CuNi „L”	-200 ... + 900 °C
Fe-CuNi „J”	-210 ... +1200 °C
Cu-CuNi „T”	-270 ... + 400 °C
Cu-CuNi „U”	-200 ... + 600 °C
NiCr-CuNi „E”	-270 ... +1000 °C
NiCr-Ni „K”	-270 ... +1372 °C
NiCrSi-NiSi „N”	-270 ... +1300 °C

Smallest span: 100 K

Measurement error:

± 0,1% referred to max. measuring range. (only guaranteed above -100 °C with Type J, above -150 °C with Types U and T, and above -80 °C with Types K, E, and N).

Type	Max. meas. range
Pt10Rh-Pt „S”	-50 ... +1768 °C
Pt13Rh-Pt „R”	-50 ... +1768 °C
Pt30Rh-Pt6Rh „B”	0 ... +1820 °C

Smallest span: 500 K

Measurement error:

± 0,15% referred to max. measuring range. (only guaranteed above 400 °C with Type B, and above 0 °C with Types S and R).

Span start and end of span can be configured freely in steps of 0,1 K within the specified max. measuring ranges.

Cold junction

Internal: Pt 100

Error of internal cold junction: ± 1,0 K

External: with reference thermostat

The cold junction temperature is configured for a constant value in the range -50...+100 °C.

Resistance thermometers

(two, three or four-wire connection)

Type	Max. measuring range	Linea- rization
Pt 100	-200 ... +850 °C	DIN
Pt 100	-200 ... +650 °C	JIS
Pt 500	-200 ... +850 °C	DIN
Pt 1000	-200 ... +850 °C	DIN
Ni 100	- 60 ... +180 °C	DIN

Smallest span: 15 K

Measurement error:

Max. meas. range	2 or 3-wire	4-wire
-200 ... +500 °C	± 0,4 K	± 0,4 K
-200 ... +850 °C	± 0,8 K	± 0,5 K

Span start and end of span can be configured freely in steps of 0,1 K within the specified max. measuring ranges.

Lead resistances

With 3 and 4-wire connection: ≤ 30 Ω per lead

With 2-wire connection: ≤ 10 Ω per lead

Current through sensor:

0,5 or 0,25 mA, depending on sensor type

Potentiometer

(two, three or four-wire connection)

Max. resistance: 4 k Ω

Smallest span: ≥ 6 Ω

Measurement error:

± 150 mΩ up to a span of 180 Ω

± 300 mΩ up to a span of 390 Ω

± 2 Ω up to a span of 2000 Ω

± 4 Ω up to a span of 4000 Ω

The measuring span can be configured in steps of 0,1 Ω.

Potentiometric transducer

(three-wire connection)

Max. resistance: 4 k Ω

Smallest span: ≥ 6 Ω

Measurement error:

± 150 mΩ up to a span of 180 Ω

± 300 mΩ up to a span of 390 Ω

± 2 Ω up to a span of 2000 Ω

± 4 Ω up to a span of 4000 Ω

The measuring span can be configured in steps of 0,1 Ω.

Direct voltage

Voltage signals with the following max. ranges can be measured:

Max. measuring range	Measurement error
-20 ... + 70 mV	± 80 μV
- 5 ... +105 mV	± 100 μV
-10 ... +210 mV	± 240 μV
- 0,5 ... + 12 V	± 6 mV
- 0,05 ... + 1,2 V	± 1 mV
- 1,2 ... + 1,2 V	± 2 mV
-12 ... + 12 V	± 12 mV

Smallest span: 5 mV

Within the specified max. measuring ranges, span start and end of span can be configured freely as follows:

In steps of 0,01 mV up to 999 mV; in steps of 1 mV above 1 V.

Input impedance:

≥ 1 M Ω for input signals ≤ 210 mV

≥ 470 k Ω for input signals > 210 mV

Direct current

Current signals with the following max. ranges can be measured:

Max. measuring range	Measurement error
- 2 ... +22 mA	± 20 μA
-22 ... +22 mA	± 44 μA

Smallest span: 0,5 mA

Span start and end of span can be configured freely in steps of 0,01 mA within the specified max. measuring ranges.

Voltage drop across input: < 1,2 V

Input circuit monitoring

Sensor type	Break	Short circuit
Thermocouple	X	-1)
Resistance thermometer	X	X
Potentiometer / pot. transducer	X	-1)
Voltage ≤ 210 mV	X	-
Voltage > 210 mV	-	-
Current	X	X

X = monitored; - = not monitored

1) Monitored, if span start is above 100 °C or 10 Ω

Digital inputs (option)

7 digital inputs acc. to DIN VDE 0411, (Section 500); max. 25 Hz, max. 32 V Logic „Low” (0): -3...+5 V Logic „High” (1): 12...30 V Sampling rate: min. 1 s

Counters

2 counters for max. 10.000 steps.

Trigger signal, starting value, up/down counting, and text for event list are freely programmable, max 25 Hz.

Sampling rate: min. 1 s

DISPLAY AND OPERATION

STN colour display

Screen size: 145 mm (5,7 inches)

Resolution: 320 x 240 pixels

16-value grey scale; 27 colours

Operation and configuration from the front by means of 8 keys, 5 of which are softkeys.

Remote configuration with a PC and the Engineering Tool and a PC interface cable (see Accessories), or by downloading from a configuration diskette.

ALARM MONITORING

Min and max limits are monitored for each channel; freely adjustable hysteresis.

OUTPUTS

1 signalling relay (standard)
Change-over contacts, 3A, 230 VAC

Transistor output (optional)
1 open collector output, max. 100 mA,
max. 25 VDC

Additional relays (optional)
4 signalling relays with NC/NO con-
tacts, 3 A, 230 VAC.
Combined switching of safe low volta-
ges (SELV) and mains voltages is not
allowed.

Voltage source (optional)
Output: 24 VDC, 50 mA

POWER SUPPLY

Supply voltage
AC 93...263 V; 48...63 Hz
UC 18...30 V; 0/48...63 Hz
(VUC=AC or DC)

Supply voltage effect
< 0,1% of max. measuring range

Power consumption
approx. 25 VA

ENVIRONMENTAL CONDITIONS

Operating temperature
0...45 °C

Temperature effect
0,03% / K

Storage temperature
-20...+60 °C

Relative humidity
≤ 75%, no condensation

CONFORMITY TESTS

CE marking
The unit meets the relevant European
Standards.

Electrical safety
According to DIN EN 61 010, Part 1
(March 1994)
Over-voltage category II
Contamination degree 2

Electromagnetic compatibility
Meets EN 50 081-1 and EN 50 082-2.
NAMUR recommendation NE21.

GENERAL

Housing
Panel-mounting to DIN 43 700.
Front dimensions: 200 x 144 mm
Depth behind panel: 225 mm
Panel cut-out:
138^{+1.0} mm x 138^{+1.0} mm
(see dimension drawing)
Panel thickness: 2...40 mm
Fixing clamps to DIN 43 834.

Protection mode
(to EN 60 529, Category 2)
Front: IP 54
Rear: IP 20

Data back-up

The RAM contents and the internal
clock are buffered for at least 4 years
by means of a Lithium battery (fitted by
the supplier). If the optional buffer
capacitor is used, the data are retained
for 2 days (operating temperature
15...25 °C)

Configuration data are stored in a non-
volatile EEPROM, and measuring data
are saved on a diskette.

Electrical connections

Input signals: via plug-in screw termi-
nals for leads with max. 2,5 mm².
Interfaces: via Sub-D connectors.

Mounting position

Vertical ± 30° according to DIN 16 257.

Weight: approx. 3,5 kg

Accessories

3 operating instructions (English,
German, French) with basic unit
2 fixing clamps
1 set of screw terminals (without 9-pin
D-type connector)
3 operating instructions (English,
German, French) for version with
RS 422/485 interface
3 operating instructions (English,
German, French) for version
with PROFIBUS-DP interface

ORDERING DATA

Order no. **9407 301 . 0 . . 1**

Measurement inputs

6 analog inputs
12 analog inputs
No analog inputs (for PROFIBUS-DP, max. 36 inputs)

↑ ↑
0
1
2

Interfaces

RS 232 (standard) ¹⁾
RS 422 / RS 485
RS 232 and PROFIBUS-DP
RS 422 / RS 485 and PROFIBUS-DP

0
1
2
3

Supply voltage

AC 93 ... 263 V, 48 ... 63 Hz
UC 18 ... 30 V, 0/48 ... 63 Hz

0
1

Basic configuration:

Inputs 4 ... 20 mA, scaling 0 ... 100 %
Inputs 1 to 6 assigned to group display 1; inputs 7 to 12 assigned to group display 2.

¹⁾ The operating instructions for the RS 232 interface must be ordered separately (see "Accessories"
below).

OPTIONS (Must be ordered separately, will be fitted in above version.) **Order no.**

Digital inputs/outputs with 7 digital inputs,
1 open-collector output, 4 signalling relays,
voltage source 24 VDC, 50 mA

Type D1

9407 301 90011

Buffer capacitor for RAM back-up
instead of Lithium battery

Type Q1

9407 301 90021

Portable housing for mobile operation

Type H1

9407 301 90031

ACCESSORIES (must be ordered separately)

Order no.

Engineering Tool, software package for PC set-up
3,5-inch diskette (English/German/French/Dutch/Spanish/Italian)

9407 301 90101

PC interface cable and connecting adapter

9407 301 90111

PC evaluating software, CD-ROM (English/German/French)
for Data Monitor KS 3010 / KS 3000

9407 301 90201

PCA communication server CD-ROM (English, German, French)
for Data Monitor KS 3010 / KS 3000

9407 301 90211

Operating instructions for basic unit

English
German
French

9499 040 52011
9499 040 52018
9499 040 52032

Operating instructions for interfaces

English
German
French

9499 040 52511
9499 040 52518
9499 040 52532

Operating instructions for PC evaluating software

English
German
French

9499 040 57811
9499 040 57818
9499 040 57832

Operating instructions for PCA com. server

English
German
French

9499 040 62211
9499 040 62218
9499 040 62232

Operating instructions for PROFIBUS-DP

English
German
French

9499 040 61811
9499 040 61818
9499 040 61832

CONNECTING DIAGRAM

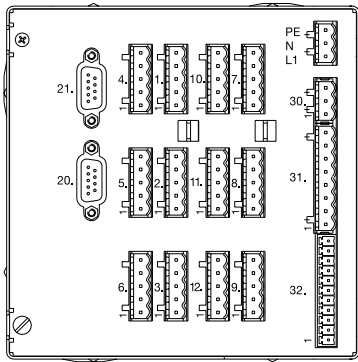

Connections for 6 and 12 inputs		
Analog inputs	Connector	Connecting symbol
Voltage input ≤ 210 mV	1 to 12	
Voltage input > 210 mV	1 to 12	
Current input	1 to 12	
Thermocouples	1 to 12	
Resistance thermometers or potentiometers in 2-wire connection	1 to 12	
Resistance thermometers or potentiometers in 3-wire connection	1 to 12	
Resistance thermometers or potentiometers in 4-wire connection	1 to 12	
Potentiometric transducers	1 to 12	

Portable housing

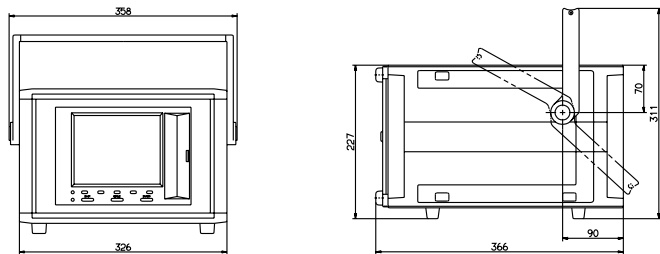

Supply voltage	Connector	
AC 93 ... 263 V UC 18 ... 30 V	N (L-) L1 PE	
Digital interfaces		
RS 232	20. 9-pin D-type female	2 RxD (receive data) 3 TxD (transmit data) 5 GND (ground) 8 CTS (clear to send)
RS 485/422 (optional)	20. 9-pin D-type female	3 TxD+ (also RxD+ with RS 485) 8 TxD- (also RxD- with RS 485) 4 RxD+ (only for RS 422) 9 RxD- (only for RS 422) 5 GND (ground)
PROFIBUS-DP (optional)	21. (9-pin D-type)	3 RxD/TxD-P ("+" receive/transmit data, B-line) 5 DGND (data transmission potential) 6 VP (supply voltage "+") 8 RxD/TxD-N ("- " receive/transmit data, A-line)
Relay outputs		
Relay K1 (change-over contacts)	30.	
Relays K2 to K5 (NO, NC and change-over contacts) (optional)	31.	
Digital I/O		
Open collector outputs (optional)	32. 3 = ground 4 = collector	
Voltage output 24 VDC/50 mA and 7 digital inputs (optional)	32. 1 +24 V output 2 ground 5 digital input 7 ... 11 = digital input 1	 Example: Input BE4, supplied from the internal voltage source (minus is connected internally)

Overall dimensions

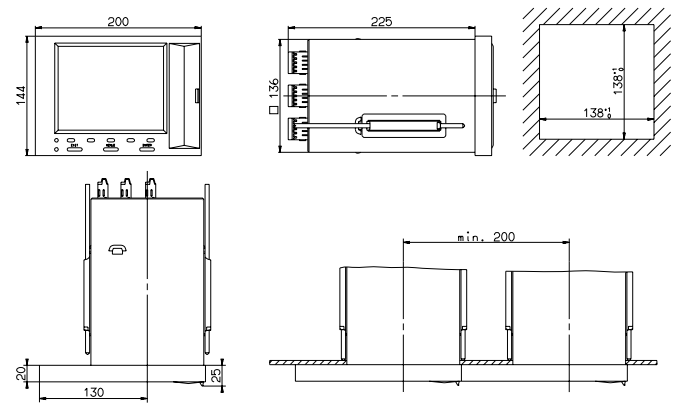

PMA
Prozeß- und Maschinen-
Automation GmbH
P.O. Box 31 02 29
D-34058 Kassel
Tel.: +49 - 5 61 - 5 05 13 07
Fax: +49 - 5 61 - 5 05 16 61
e-mail: export@pma-online.de
Internet: http://www.pma-online.de

Your local partner: