

Stückliste / Parts list

Pos.	Artikel-Nr.: <i>order number</i>	Bezeichnung <i>title</i>
1	1097764	Pyrometer CellaTemp PX 17 AF 1 <i>Pyrometer CellaTemp PX 17 AF 1</i>
2	1090728	Montagekombination PA 15-007 <i>Mounting PA 15-007</i>

Gewicht: 7.020 Kg
Weight: 7.020 Kg

Seite 1 von 1
Page 1 of 1



Optik

Optik	min. [mm]	max. [mm]
Standard Optik PZ 10.01 <i>Standard lens PZ 10.01</i>	35,0	44,4
Nah Optik PZ 10.05 <i>close-up lens PZ 10.05</i>	35,0	44,4
Standard Optik PZ 15.03 <i>Standard lens PZ 15.03</i>	51,5	65,0
Standard Optik PZ 20.01 <i>Standard lens PZ 20.01</i>	49,8	69,9
Nah Optik PZ 20.03 <i>Close-up lens</i>	49,7	67,9
Panorama Optik PZ 4.0.03 <i>Panorama Optik PZ 4.0.03</i>	52,1	67,9
Weitwinkel Optik PZ 20.05 <i>Wide-angle lens PZ 20.05</i>	62,8	64,7
Tele Optik PZ 20.06 <i>Telephoto lens PZ 20.06</i>	93,0	112,0
Spezial Optik PZ 20.08 <i>Special lens PZ 20.08</i>	35,0	44,4

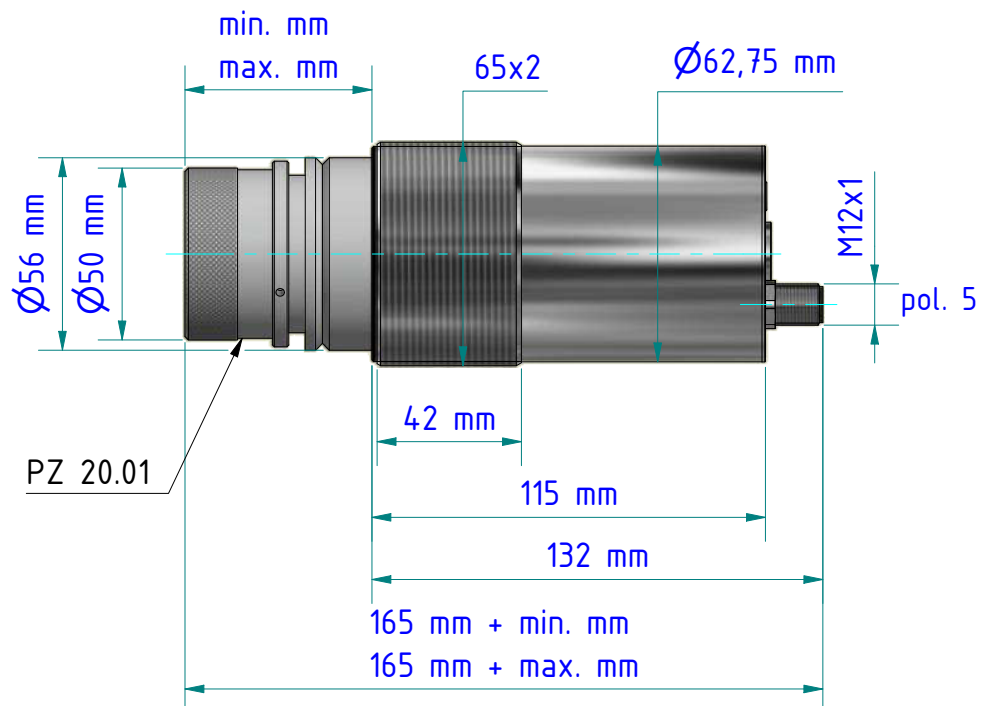

Anbaufansch PZ 20/F
Flange PZ 20/F
 nr./no. 561172

Axialluftdüse PZ 20/A AF1
Air purge PZ 20/A AF1
 nr./no. 561176

Saphir-Scheibenscharnier PZ 15/I AF2
Sapphire window with hinge PZ 15/I AF2
 nr./no. 1066857

Kühlarmatur, geschlossen PA 20/M AF1
Cooling jacket, sealed PA 20/M AF1
 nr./no. 1027765

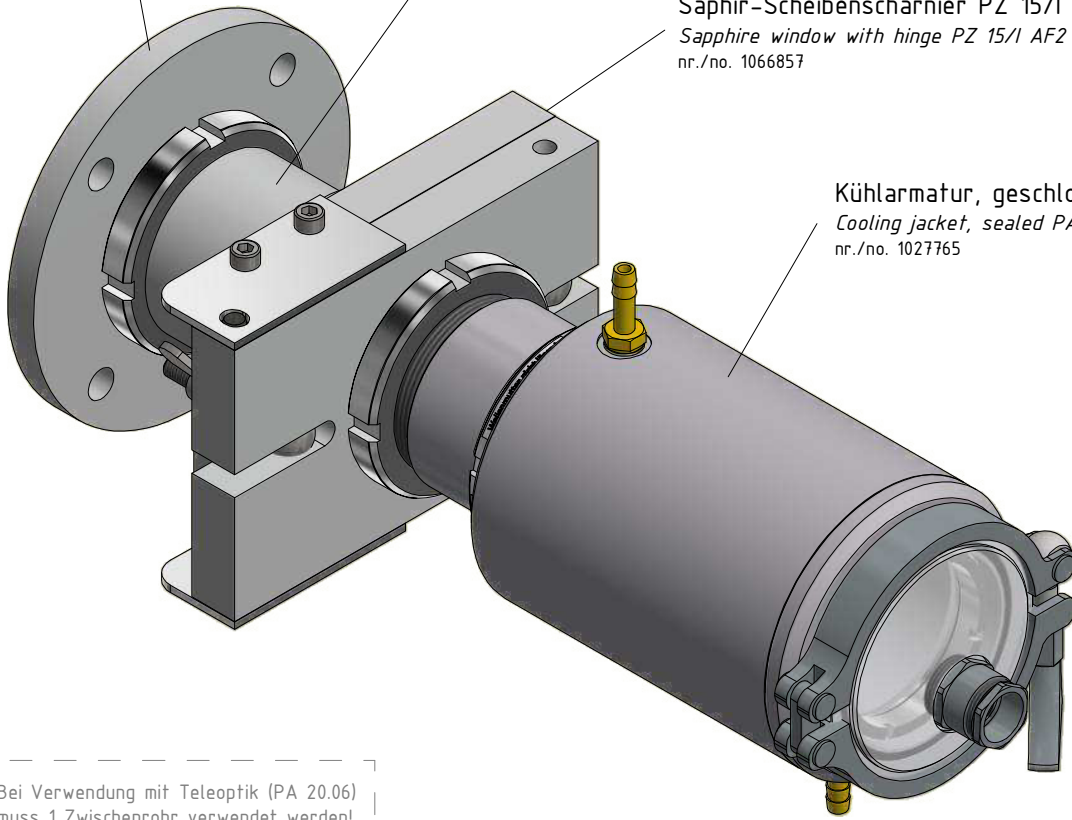

* Bei Verwendung mit Teleoptik (PA 20.06) muss 1 Zwischenrohr verwendet werden!
When using a telephoto lens (PA 20.06), you must use 1 intermediate tube.

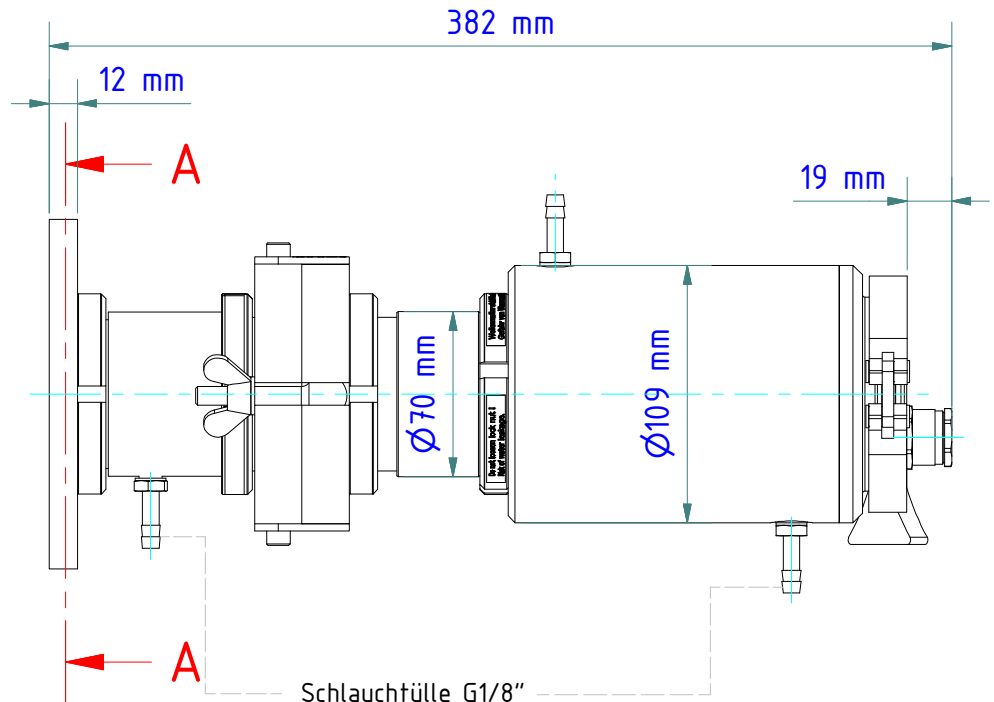
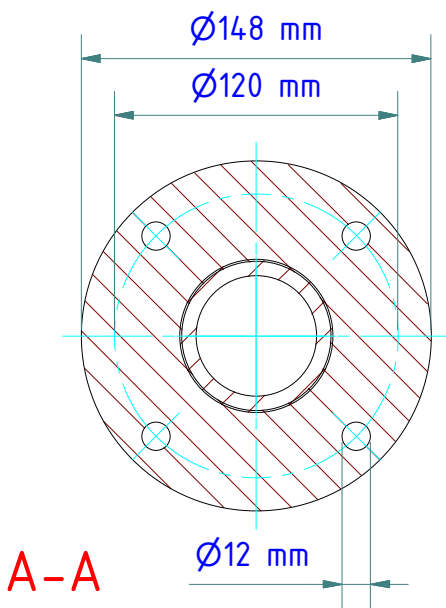

Schlauchtülle G1/8"
 für Schlauch mit lichter Weite 8 bis 9 mm
Hose nozzle G1/8"
 for hose with inner width 8 to 9 mm

Gewicht: 5.980 Kg
 Weight: 5.980 Kg

Seite 1 von 1
 Page 1 of 1